

FRONT LOADING

Super Washer

Model: 824N

OWNER'S MANUAL

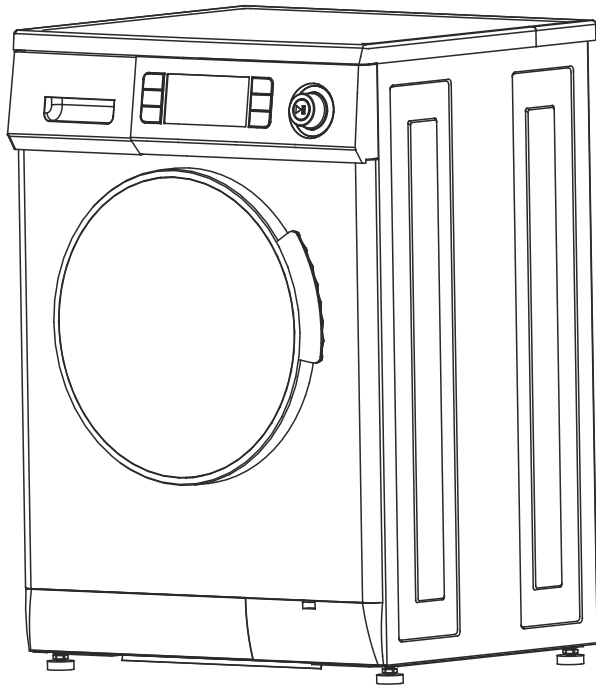

TABLE OF CONTENTS

Warranty.....	1
Technical Data	2
Introduction	3
Important Safety Instructions.....	4
Helpful Hints.....	5
Pre-installation.....	5
Diagram of the Combo	6
Installation Instructions	7
Unpacking & Levelling	8
Electrical	9
Plumbing	10
Program Selection Chart.....	11
Operating Instructions.....	12
Control Panel	13
Understanding Fabric Care Labels	15
Winterizing.....	15
Maintenance	16
Stain Removal Chart	17
Troubleshooting	19
Diagnostics Menu.....	20

**Please read the Owner's Manual carefully before using your
new Fully Automatic Washer**

WARRANTY INFORMATION

Your appliance is protected by this warranty under normal, personal, family or household use (1Year), and limited commercial use (90 days), in USA and Canada.

WARRANTY

Consolidated Brands undertakes to the consumer-owner to repair or, at our option, to replace any part of this product which proves to be defective in workmanship or material under normal personal, family or household use, in the USA and Canada, for a period of one year from the date of original purchase. For commercial use, the product is warranted for a period of 90 days. During this period, we will provide all labor and parts necessary to correct such defect, free of charge, if the appliance has been installed and operated in accordance with the written instruction with the appliance. Ready access to the appliance, for service, is the responsibility of the consumer-owner. We may require return of products or parts to our warranty department for which the shipping charges are to be incurred by the consumer. If a return or replacement is required, allow 3-4 weeks to process. All repairs or replacements are warranted only for the remainder of the original warranty period. Charges may incur if warranty coverage is not applicable. Service would be provided from Monday to Friday between normal business hours.

GENERAL

Since it is responsibility of the consumer-owner to establish the warranty period by verifying the original purchase date, Consolidated Brands recommends that a receipt, delivery slip or some other appropriate payment record be kept for that purpose. Remember to send in your Warranty Registration Card so that a proof of your purchase exists with Consolidated Brands. You can also register online by typing the following link **www.ApplianceDesk.com**. This warranty gives you specific legal rights, and you may also have other rights which vary from State to State.

WARRANTY SERVICE

This warranty is given by:

**Consolidated Brands
10216 Georgibelle Drive, Suite 900D
Houston, TX 77043-5249**

For Service Contact:

Phone or Text: 1-800-776-3538
Email: service@appliancedesk.com
Web: www.ApplianceDesk.com

EXCLUSIONS

In no event shall Consolidated Brands be liable for incidental or consequential damages or for damages resulting from external causes such as abuse, operation misuse, neglect, alterations, normal wear and tear, incorrect voltage or acts of God. This warranty does not cover service calls which involve defective workmanship, damage due to other products while combined use with this product or materials covered by this warranty. Accordingly, diagnosis and repair costs for a service call which involves defective workmanship or materials will be the responsibility of the consumer-owner.

Most work is covered. The defining factor is has the machine malfunctioned (Consolidated Brands is responsible) or has the customer omitted or done something to cause or limitation of incidental or consequential damages, so the above limitation or exclusion may not apply to you.

THE FOLLOWING WORK ARE NOT COVERED UNDER WARRANTY:

Installation

1. Non-removal of shipping rods, causing vibration / internal damage.
2. Non-adjustment of feet to level machine, causing vibration / internal damage.
3. Not conforming to minimum space requirements for Built-in installation, causing excess heat and resulting in damage to internal components.
4. Installation in a corrosive environment
5. Incorrect water pressure i.e below 7.25 psi or above 145 psi
6. Incorrect water inlet hose installation (use only factory supplied hoses with metric threads on the L shaped side to fit water valves)

Maintenance

1. Non-cleaning of coin trap for debris, causing the unit to not drain out water and resulting in drain pump malfunction.
2. Improper maintenance (such as but not limited to scale build-up, freeze damage)

Damage

1. Breakage of cosmetic parts eg. Door handle, knob.

Other

1. Accident, abuse or misuse
2. Using of solvents to clean the machine or wash clothes causing damage.
3. Misapplication of this product e.g. Use in a non household/commercial environment.
4. Any other cause not due to defects in materials or workmanship
5. Problems or damage due to fires, flooding, electrical surges, freezing or any acts of God
6. Any damage cause by poor water quality
7. Operating the appliance with anything other than potable water at all times
8. Force majeure

TECHNICAL DATA

Model	824 N
Rated Voltage	110-120V/60Hz 5A
Washing input power	240 W
Spin input power	450 W
Capacity	13lbs / 6Kg
Spin Speed	1200 rpm
Programs	14
Water pressure	7.25-145 (psi) / 0.05-1(Mpa)
Dimensions (HxWxD)	33.5x23.6x22 (in) / 85x60x55.8 (cms)
Net Weight	152lbs / 68.9Kg



Intertek

4007606

Electrical Testing Laboratories

US N° 4007606 CANADA

The ETL Listed Mark is the legal equivalent to the UL and CSA Listed Marks

Note: All rights reserved.
Designs, Specifications and Manual subject to change without notice

INTRODUCTION

Congratulations on your new Washer. In addition to its contemporary design, this is a highly sophisticated engineered product that will give you many years of satisfaction.

Here are some of the best reasons for buying your Washer

1. **Space Saving**

The washer is a compact size unit that can fit conveniently saving space in your home.

2. **Placement Options**

The washer's compact size makes it perfect for placement in any room of your home.

3. **Easy Operation**

This appliance is simple to use with easy to operate controls. Fully digital color coded LED display that makes it easy to understand and operate the machine.

4. **Better Clothing Appearance**

This Washer has no agitator to damage your clothes so they look better and last longer.

5. **High spin speed**

With a high spin speed of 1200 rpm, more water is extracted, allowing improved dry times.

6. **Water Saving**

The automatic water level feature determines the correct amount of water required based on the quantity of clothes which helps save water.

7. **Add-a-sock**

In this feature, the program can be stopped at any time to add forgotten items to the wash.

8. **Lint Free Maintenance**

Since the machine has a self-cleaning pump, this appliance needs no cleaning of lint after drying. Instead, there is a convenient coin trap.

9. **Portability**

This washer can be made portable with the installation of the Portability Kit (Accessory Part# 1070 sold separately) where needed.

10. **Energy Saving**

The washer is a horizontal-axis machine which uses 1/3rd the water than a regular top-loading machine. Energy is saved in heating the reduced amount of water.

IMPORTANT SAFETY INSTRUCTIONS

Your safety and that of your children



Your washing machine has been built in compliance with safety regulations, to protect you and all your family.

WARNING – To reduce the risk of fire, electric shock, or injury to persons when using your appliance, follow basic precautions, including the following:

1. Read all instructions before using the appliance.
2. Do not wash articles that have been previously cleaned in, washed in, or spotted with gasoline, other flammable or explosive substances, as they emit vapors that could ignite or explode.
3. Do not allow children to play on or in the appliance. Close supervision of children is necessary when the appliance is used near children.
4. Before the appliance is removed from service or discarded, remove the door.
5. Do not reach into the appliance if the tub or drum is moving.
6. Do not install or store this appliance where it will be exposed to the weather.
7. Do not tamper with controls.
8. Do not repair or replace any part of the appliance or attempt any servicing unless specifically recommended in the user-maintenance instructions or in published user-repair instructions that you understand and have skills to carry out.
9. Do not add gasoline, dry-cleaning solvents, or other flammable or explosive substances to the wash water. These substances give off vapors that could ignite or explode.
10. Under certain conditions, hydrogen gas may be produced in a hot water system that has not been used for 2 weeks or more. **HYDROGEN GAS IS EXPLOSIVE.** If the hot water system has not been used for such a period, before using the washer, turn on all hot water faucets and let the water flow from each for several minutes. This will release any accumulated Hydrogen.
11. Do not use fabric softeners or products to reduce static unless recommended by the manufacturers of the fabric softener product
12. Check the Coin Trap every few months to remove any coins, buttons or similar size objects.

SAVE THESE INSTRUCTIONS

SAFETY

 CAUTION 	The model number and the serial number are on the label affixed to the back of the unit. These numbers are also available on the front of the cabinet behind the door.
RISK OF ELECTRIC SHOCK DO NOT OPEN	You should note the model and serial numbers of this unit in the space provided. Retain this booklet as a permanent record of your purchase to aid in identification in the event of theft.
CAUTION: TO REDUCE THE RISK OF ELECTRIC SHOCK, DO NOT REMOVE COVER (OR BACK). NO USER SERVICEABLE PARTS INSIDE. REFER SERVICING TO QUALIFIED SERVICE PROFESSIONALS.	MODEL# _____ SERIAL# _____

HELPFUL HINTS

1. Your Washer spins at a high 1200 rpm spin speed, which will extract more water especially from absorbent fabrics and reduce the degree of dampness as This will cut down on your drying time.

2. FABRIC SOFTENER: After the wash cycle, the clothes can get stuck to the sides of the drum. USING LIQUID FABRIC SOFTENER WILL CAUSE THE CLOTHES TO UNSTICK IMMEDIATELY AND REDUCE WRINKLES.

PRE-INSTALLATION

1. The unit must be installed on a strong leveled surface in a protected, dry and well-ventilated area, with a power and water supply of sufficient capacity and a sufficient outlet in close proximity.
2. Installation on Carpet or Wood increases vibrations.
 - Carpets – place on light carpet only.
 - Wood – brace floor with screws and place additional sheets of plywood before installation.
3. This unit's installation and grounding should be done in accordance with local codes by a qualified installer. "Installation Instructions" are included in this manual for the Installer's reference.
4. The unit should be plugged into a properly grounded three (3) prong electrical outlet of 110V/60Hz with minimum 15 Amps, It should not be controlled by a wall switch or pull cord which might be turned off accidentally.

DIAGRAM OF THE FULLY AUTOMATIC WASHER

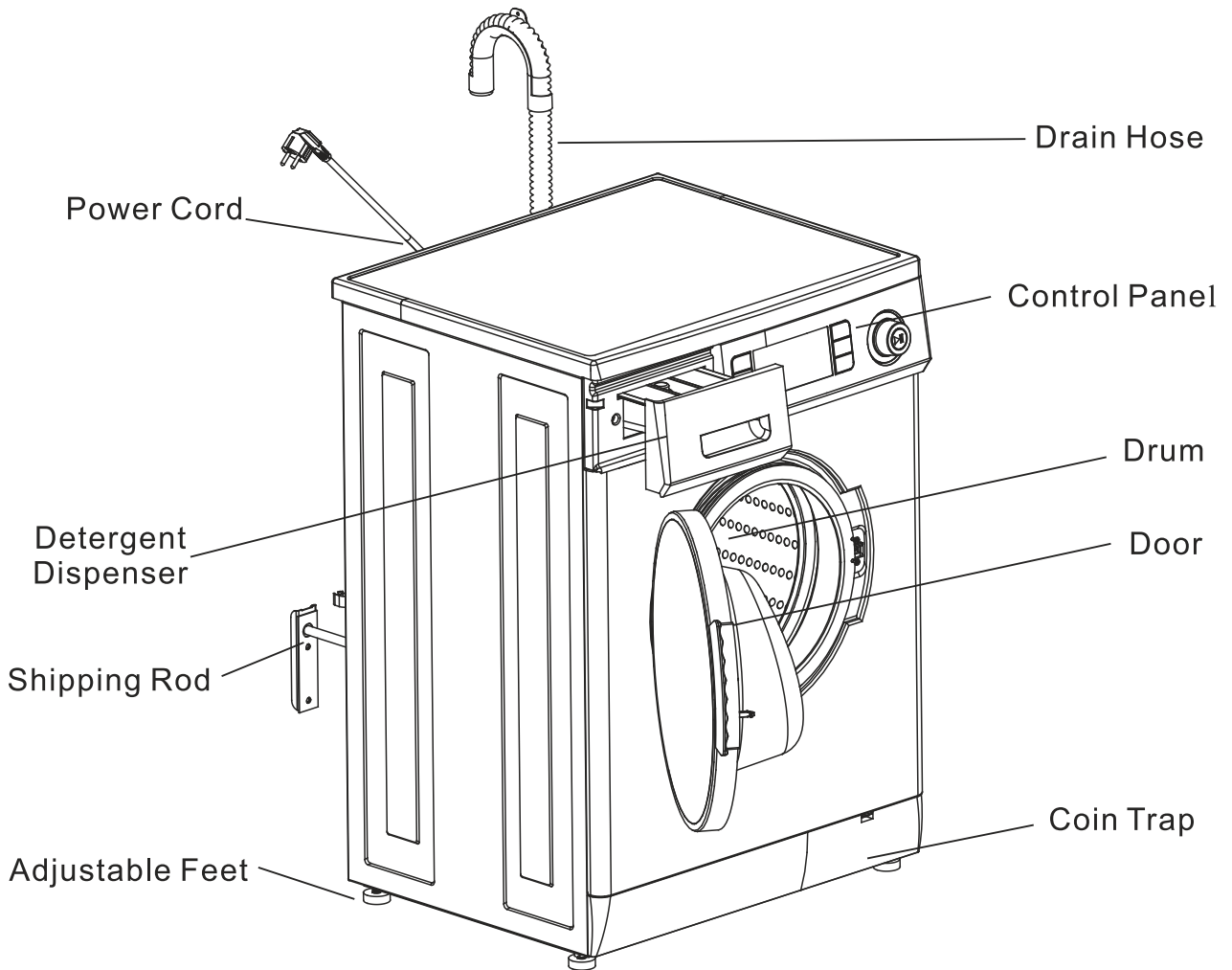

Factory supplied accessories

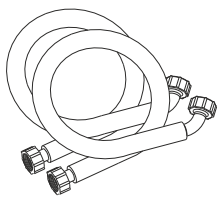

Inlet hose (2)

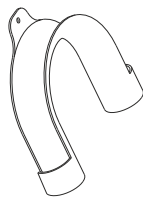

U-Connector for Drain hose

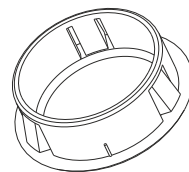

Blanking Caps (2)

INSTALLATION INSTRUCTIONS

Handling

Please handle the machine carefully and use appropriate means while lifting and moving the machine so that it does not get damaged. Do not drag the machine to your floor and, or, to the machine. Do not hold on to protruding parts when lifting

Disposing of the packing

The shipping package has protected your new washing machine on its way to your home. All packaging materials are non-polluting and recyclable. Please contribute to a better environment by disposing of packing material in an environmentally conscious manner.

⚠ DANGER ⚠

Keep children away from the shipping carton and packing components. Danger suffocation from plastic foil and folding cartons.

Disposing of your old appliance

Old Appliances are not worthless trash! Valuable raw material can be recycled from old appliances. To prevent children from locking themselves in the appliances, disable the door locking or remove the door.

Factory - supplied Equipment

Inside the drum there is a packet of accessory parts supplied with your washer. Check that all the accessory parts supplied for your model are there. If any parts are missing contact your dealer.

Any residual moisture inside the drum is due to the final testing which every washing machine undergoes before leaving the factory.

Installation area

⚠ DANGER ⚠

Appliance stability is very important otherwise washing machine could "wander" during the spin cycles.

The installation area must be solid and even. Soft floor surfaces such as carpets or surfaces with foam backing are not suitable.

⚠ DANGER ⚠

Do not install the washing machine outdoor or in an area exposed to freezing condition. frozen hoses can tear / burst.

If the washing machine is located in a room which will be exposed to temperatures below freezing point, or if it is located in a cabin that is being shutdown for the winter, any residual water in the pump or water inlet hoses must be drained.

Removing the shipping rods

⚠ CAUTION ⚠

The shipping rods must be removed before using the appliance for the first time and must be retained for any future transport. (e.g when moving)

UNPACKING, LEVELING & POSITIONING

Remove the packing and check that the Washer is undamaged. If you have any doubt, do not use the Washer and call Customer Service. Keep all packing parts (plastic bag, foam rubber, screws, etc.) out of the reach of children since they could be dangerous.

Important: The inside of the Washer consists of a free floating drum that is affixed with shipping rods at the back of the cabinet during transport (Fig.1). The power cord can be accessed by removing the shipping rods (Fig. 2 & 3). Close the holes left open by the rods with the caps provided (Fig. 4). The screws also need to be reinstalled (Fig. 4).

It is important for the machine to be perfectly level. For this reason, the machine is fitted with adjustable feet used for leveling the machine before use (Fig. 5).

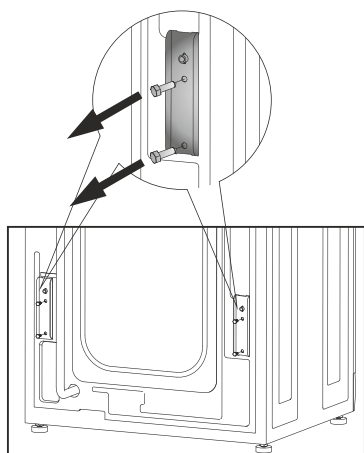

Fig.1



Fig.2

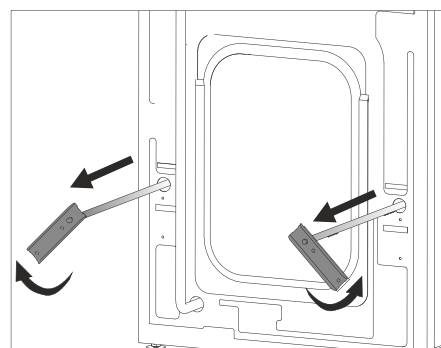

Fig.3

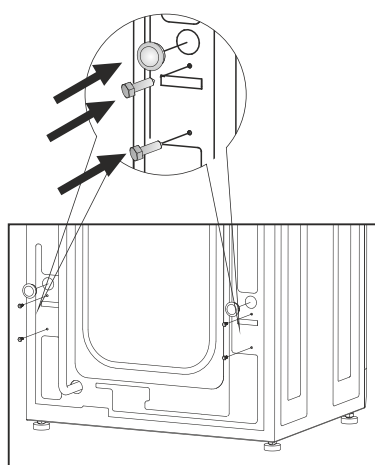

Fig.4

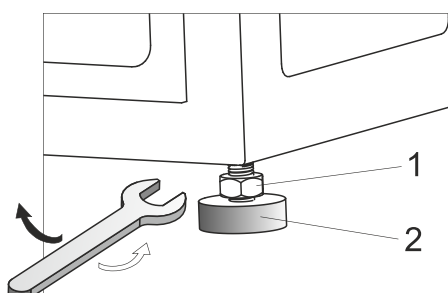

Fig.5

ELECTRICAL

CONNECTION

Connect the plug to a power outlet – 110V/60Hz with minimum 15 Amps. Make sure that the voltage and frequency available correspond with those stated on the serial number plate located on the machine. Do not use adaptors or extension cords since they could result in overheating and burn out.

POWER SUPPLY

CAUTION NEVER USE AN EXTENSION CORD WITH THIS APPLIANCE.

This washer must be connected to an individual circuit identical to the specified on the rating plate of the loading port protected by fuses or circuit breaker conforming to local codes.

GROUNDING

This appliance must be grounded. In the event of malfunction or breakdown, grounding will reduce the risk of electric shock by providing a path of least resistance for electric current. This appliance is equipped with a power cord having an equipment-grounding conductor and a grounding plug. The plug must be plugged into an appropriate outlet that is properly installed and grounded in accordance with all local codes and ordinances.

WARNINGS

- Improper connection of the equipment -grounding conductor can result in a risk of electric shock. Check with a qualified or service representative or personal if you are in doubt as to whether the appliance is properly grounded.
- Do not modify the plug provided with the appliance: if it will not fit the outlet, have a proper outlet installed by a qualified electrician.

Note: If the electrical power supply does not meet the specifications listed above, please call a licensed electrician.

ADA COMPLIANCE

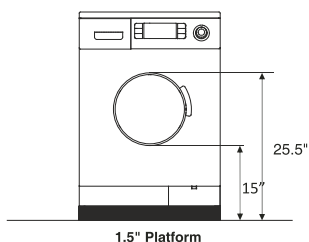

Use 1.5" height platform to make the machine ADA compliant.

PLUMBING

CONNECTING TO THE WATER FAUCET

Please read the following steps carefully

1. Connect the straight end of the hot-water hose to the hot-water faucet (Fig.5)
2. Connect the straight end of the cold-water hose to the cold-water faucet (Fig.5)
3. Connect the L-shaped end of the hot-water hose to the inlet valve marked "H" (Fig.6)
4. Connect the L-shaped end of cold-water hose to the inlet valve marked "C" (Fig.6).

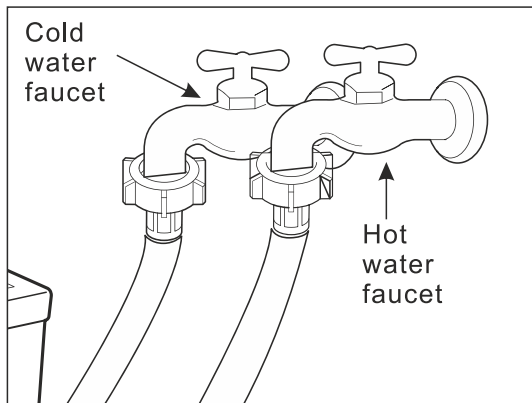

(Fig.5)

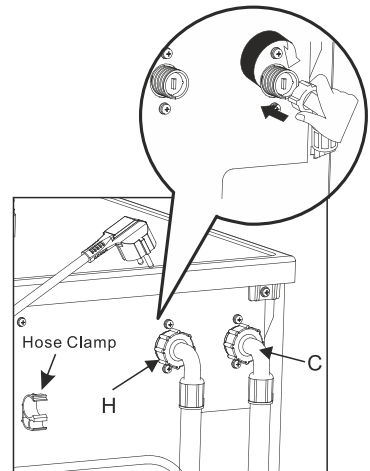

(Fig.6)

CONNECTING THE DRAIN HOSE

Connect the drain hose to a drain duct (with internal diameter of at least 1.6 inches) or place it for drainage in to a sink or a tub, ensuring that there are no kinks or bends. The free end must be at a height of 24"-40" from the floor. The hose can be held in place using the white plastic clamp on the upper part of the back panel (Fig.6)

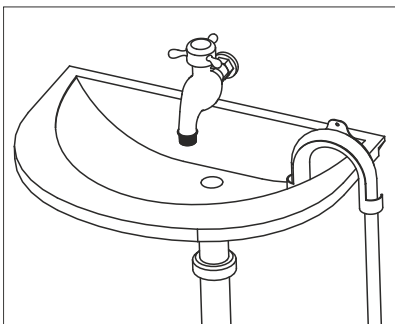

(Fig.7)

Height difference between the installation location of the washing machine and the drainage point:
Minimum 24", and Maximum 40".

- Attach water drain hose to U-Connector.
- Hook the U-Connector over the side or stand pipe (Fig 7.)
- When the water is being drained, check that the water flow out of the hose is adequate.

PROGRAM SELECTION CHART

Program	Description of load	Features	Suggested Washing times
– Heavy	Thick cottons (towels, jeans)	Hot water wash 1200 rpm spin	68 minutes
– Towels	Mixed cottons (t-shirts, jeans)	Hot water wash 1200 rpm spin	55 minutes
– STANDARD	Mixed cottons	1200 rpm spin Warm water wash	55 minutes
– Quick 20	Cotton blends, light fabrics	Cold water wash 1200 rpm spin	20 minutes
– Baby	Cotton blends, light fabrics	Warm water wash 500 rpm spin	40 minutes
– Delicate	Silks	Cold water wash 500 rpm spin	40 minutes
– Wool	Woolens	Cold water wash 500 rpm spin	40 minutes
– Quiet	Light fabrics	Cold water wash 800 rpm spin	35 minutes

USEFUL TIPS

Denim Alert:

Some overalls have straps with hooks that can damage the drum of your washing machine or other garments during the wash. To minimize the risk, place hooks in the pocket and fasten with safety pins.

Vacations: unplug the appliance:

It is recommended that you should unplug the machine from the socket and turn off the water supply. Leave the door ajar to allow air circulation to the drum and the door gasket area. This will prevent unpleasant odors.

OPERATING INSTRUCTIONS

1. Make sure the Washer is turned off. (Power Indicator light should be off).
2. Separate clothes by type, color and degree of soiling.
3. For small items such as socks, children's garments and small towels please use a **Washing Net Bag**.
4. Load clothes of the selected type loosely into the drum.
5. Close the Washer door. You will hear a click when it is correctly closed.

Use High Efficiency (HE) detergent about 1 table spoon.

Add detergent to Dispenser A.

You can add fabric softener and pre-wash detergent as shown in the diagram to compartment B & C.

Detergent Dispenser

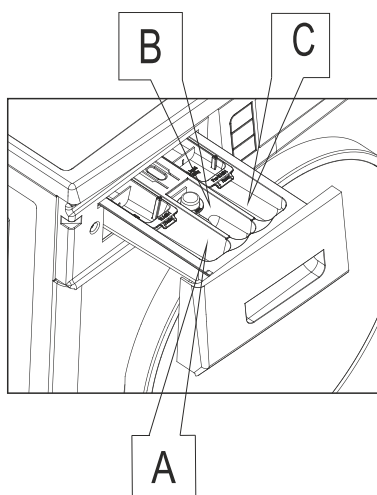

Dispenser A:
Detergent for main wash

Dispenser B:
Fabric Softener

Dispenser C:
Detergent for pre-wash

**The blue cups are only for liquid detergent.
Please do not add powder in these cups.**

Note : concentrated fabric softener must be diluted with a little water before being poured into the dispenser
(This prevents the over flow siphon from getting blocked)

Add detergent in Dispenser C, only for Pre-Wash cycle.

Control Panel

Super Washer

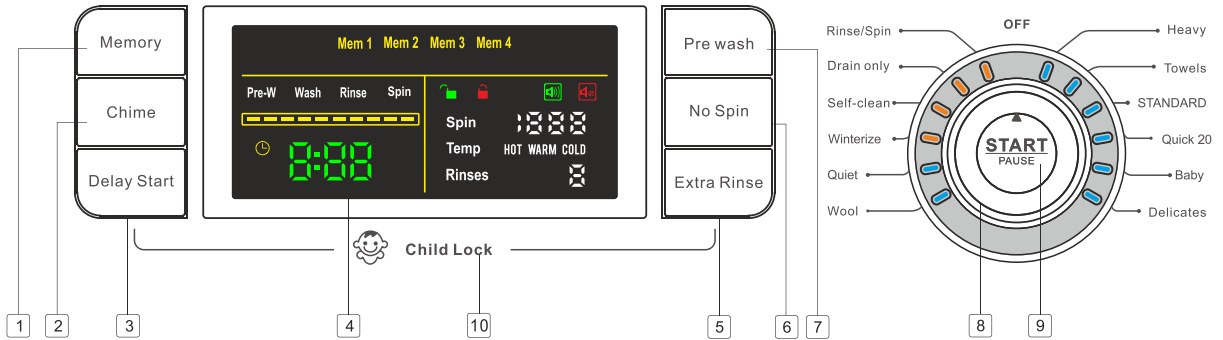

- 1** **Memory button** Press this button to select once of the four positions, then select the additional options for your favorite washing cycles, then press Start/Pause button to run this program, and this program will be memorized. If you want to run the memorized program later, press this button to select one of them, then press Start/Pause button. Turn the dial to align "OFF" to cancel the memory operation.
- 2** **Chime button** Press this button to turn on, or off the chime before you start the washing cycle.
- 3** **Delay Start button** Press this button to select the delay time from 1 to 24 hours in one hour increments before the wash cycle started
- 4** **Color LED Display** To display the selected program, such as the water selection, spin speed, remaining time, rinse times, water level and error messages.
- 5** **Extra Rinse button** Press this selection button to add one more rinse cycle to the selected washing program.
- 6** **No Spin button** Press this selection button to eliminate the spin function. This function will keep the laundry in the rinse water after the last rinse cycle is finished. Press this button again, it will drain out the water and proceed to last spin cycle.
- 7** **Pre Wash button** Press this button to add a prewash cycle to the selected washing program. This cycle is helpful to clean heavy soiled clothes
- 8** **Program Dial** Turn dial to point to one of the 12 programs depending on the load to turn the unit on. Move it to the off position to turn the unit off.
- 9** **Start/Pause button** Press this button to start or interrupt the selected wash program, or to view the program during a cycle.
- 10** **Child Lock** In order to deactivate the function to the controls, to prevent altering cycle, press and hold the "Extra Rinse" and "Delay Start" buttons.

Display Panel Symbols

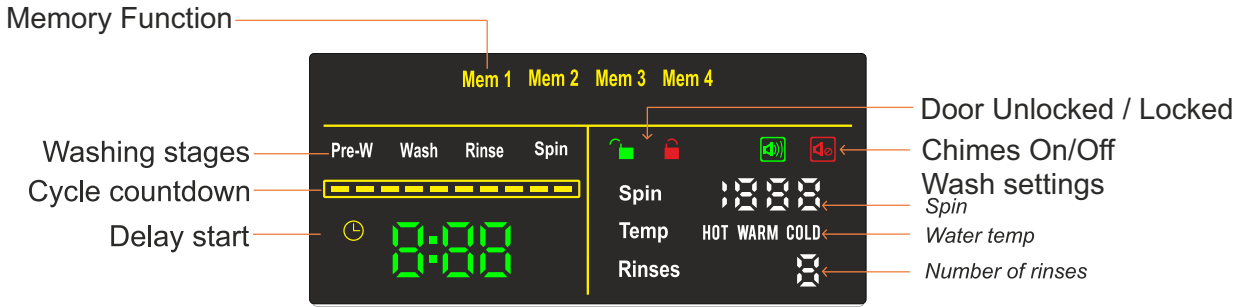

How to Run a Wash Cycle

1. Rotate knob to one of the wash settings
 2. Press START
- (Standard settings, for custom settings select accordingly)

Add-a-sock Feature



The wash program can be stopped at any time to add forgotten items to the laundry

- Press pause for 5 seconds
- Door will open 2 mins after draining water so that it does not overflow.
- Load clothes. Close door.
- Press START The cycle will continue from the point it stopped

How to stop the wash cycle

- The wash program can be stopped at any time.
- Press pause for 5 seconds
- Turn knob to OFF position
- To drain water turn knob to DRAIN ONLY on left side.

Understanding the door lock function

Pressing the start button  will lock the door  → . The wash cycle will start and will continue until the whole program is completed. The door will be locked and cannot be opened until 2 minutes after the wash cycle ends. Please do not try to force the door open. **Breakage of the door handle is not covered by warranty.**

USEFUL TIPS

Denim Alert:























Some overalls have straps with hooks that can damage the drum of your washing machine or other garments during the wash. To minimize the risk, place hooks in the pocket and fasten with safety pins.

Vacations: unplug the appliance:

It is recommended that you should unplug the machine from the socket and turn off the water supply. Leave the door ajar to allow air circulation to the drum and the door gasket area. This will prevent unpleasant odors.

UNDERSTANDING FABRIC CARE LABELS

The symbols on labels of your garments will help you in choosing the suitable wash program, the right temperature, wash cycles, and ironing methods. Please review the chart below.

Machine Wash Cycle	 Standard	 Permanent Press/ wrinkle resistant	 Delicate/ Gentle	 Hand wash	 Do not wash	 Do not wring
Water Temp.	 Hot (50°C/120°F)	 Warm (40°C/105°F)	 Cold/Cool (30°C/85°F)			
Tumble Dry	 Dry	 Normal/ Cotton Heavy Duty	 Perm Press/ wrinkle resistant	 Delicate/ Gentle	 Do not tumble dry	 Do not dry
Special Instructions	 Line dry/ Hang to dry	 Drip dry	 Dry flat	 In the shade		
Bleach Symbols	 Bleach	 No-chlorine bleach	 Do not bleach			

WINTERIZING

How to winterize for cold weather

- 1) Pour 2 cups of RV type Antifreeze in soap dispenser.
- 2) Select WINTERIZE cycle on knob and press START. Machine will Rinse & Spin.
- 3) Open coin trap once cycle is finished and drain out remaining water.
- 4) Shut off water at both faucets and disconnect water inlet hoses from faucets and drain

MAINTENANCE

Your Washer has been designed to operate with easy maintenance.

Follow these simple maintenance procedures to obtain optimum performance:

1. Make sure that your machine was installed according to the correct installation procedures mentioned in this Manual.
2. Do not use solvents either to clean the machine or to wash clothes.
3. Keep the inside of the detergent dispenser clean.

Cleaning the coin trap

- Switch off the Washer
- Open the service flap. (bottom right corner)(Fig.11)
- Carefully unscrew the coin-trap cover. **Warning: Some residual water will flow out. (Approx. 1 Cup)**(Fig.12)
- Remove foreign objects/fluff from inside and clean the interior. (Fig.13)
- The pump impeller wheel located behind the water filter, must be able to rotate. Remove detergent residue and fluff from the pump cover thread and pump housing.
- Insert the coin-trap cover and screw tight.
- Insert and close the service flap.

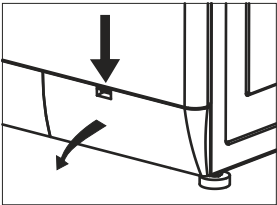

(Fig.11)

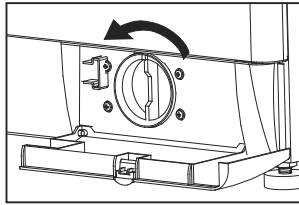

(Fig.12)

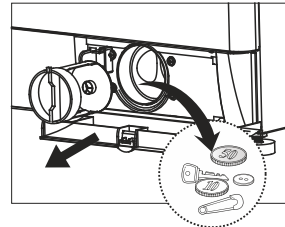

(Fig.13)

Cleaning the Detergent drawers and Recess

- Press release lever on the inside of the drawer and pull it out. (Fig. 14)
- Remove the cap from the Fabric Softener compartment.
- Wash all of the parts under running water.
- Clean the drawer recess with a small brush. (Fig.15, Fig.16)
- Reinsert the cap (Pushing it firmly into place).
- Push the drawer back into place.
- Run a rinse program without any laundry in the drum.

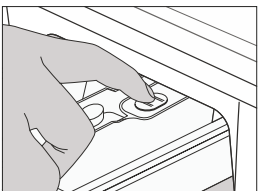

(Fig.14)

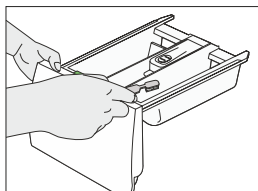

(Fig.15)

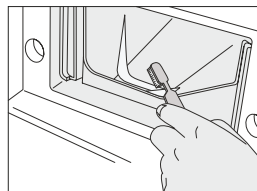

(Fig.16)

STAIN REMOVAL CHART

Blood

Rinse or soak fresh stain in cold water. Work detergent into any remaining stain. Rinse. If stain persists, put a few drops of ammonia on stain and repeat detergent treatment. Rinse. If necessary bleach.

Burn Marks

Rinse or soak in cold water. Work detergent into stain. Rinse. Bleach, if necessary. Stain may be impossible to remove

Candle Wax

Scrape off excess. Place stain between clean white blotters or several layers of facial tissues. Press with warm iron. Sponge with cleaning fluid. If dye spot remains, bleach.

Chewing Gum

Rub with ice to harden. Scrape off excess with dull blade. Sponge with cleaning fluid.

Chocolate or Cocoa

Soak 15 minutes in cold water. Rub detergent paste into stain, then rinse thoroughly. Launder in hottest water safe for fabric. If colored stain remains, sponge with hydrogen peroxide, rinse and launder.

Coffee or Tea

Soak fresh stains immediately in cold water. Then use bleach treatment with hottest water safe for fabric.

Cosmetics: eye shadow, lipstick, liquid make-up, mascara, powder, pancake make-up or rouge

Apply undiluted liquid detergent to stain, or dampen stain and rub in soap or detergent paste until thick suds are formed. Work in until stain is gone, rinse well. Repeat if necessary. If color remains, bleach if safe for fabrics.

Cream, Ice Cream or Milk

Sponge stain with cool water or soak stain in cool water for 30 minutes or longer. If stain remains, work detergent on spot then rinse. Bleach if necessary.

Deodorants and Antiperspirants

Wash or sponge stain thoroughly with warm water and detergent; rinse. If stain remains, bleach with hot sudsy water. Launder. You may be able to restore fabric color by sponging with ammonia. Rinse thoroughly.

Dye

Rinse or soak in cold water. Work detergent into stain. Rinse. If necessary, bleach. Stain is not always possible to remove. A commercial color remover may also be used.

Egg or Meat Juice

Rinse in cold water. If stain remains, sprinkle with meat tenderizer, let stand 15-20 minutes. If stain still remains, sponge with cleaning fluid or diluted bleach. Launder in hot water. The use of hot water first may set stain.

Fabric Softener Stain

Rub with bar soap until stain has lightened. Rinse thoroughly. Launder. Rubbing alcohol is sometimes effective in the color of the garment can take it. Launder. If desired, dry cleaning can be used.

Felt tip pen

Spray spot with cleaners suitable to this purpose. Sponge stain thoroughly. Rinse with cold water. Reapply cleaner if necessary .

Fruit, Wine

Soak fresh stains immediately with cool water. Then use bleach treatment with hottest water safe for fabrics. Launder.

Grass

Work detergent into stain. Sponge with denatured alcohol. Bleach, if necessary.

Grease or Oil

Scrape away excess. Rub detergent paste or a general purpose liquid household cleaner into stain, rinse with hot water. If stain remains, sponge thoroughly with a grease solvent. Dry. Repeat if necessary. To remove yellow stain, use a chlorine or oxygen bleach.

Ink

Some ball-point inks are set by water. First test a scrap of cloth. Sponge stain repeatedly with acetone, amyl acetate or rubbing alcohol. Hair spray is effective. Launder. Bleach if necessary. Use amyl acetate on triacetate, arnel, dynel and verel. Use acetone on other fabrics. NOTE: Some inks cannot be removed.

Ketchup

Scrape of excess. Soak in cold water 30 minutes. Pre-treat with a detergent paste. Launder.

Mildew

Brush off surface growth to keep mold spores from spreading. Dip article into solution of ½ cup bleach per 1 gallon of cool sudsy water for 5 to 10 minutes. Rinse well. Launder.

Mud

Let stain dry; then brush well. Rinse repeatedly in cool water until mud comes out. Launder. (Hot soaps suds set a red or yellow clay stain).

Mustard

Soak in hot detergent water for several hours. If stain remains, bleach.

Nail Polish

Treat while fresh, scraping or wiping off as much as possible, before it dries. Place stain face down on white paper towels. Sponge back of stain acetone (nail polish remover) or sponge with denatured alcohol and a few drops of household ammonia. Sponge stain

frequently. Launder with water at temperature suitable for fabric. *Do not use acetone on acetate, arnel, dynel or rayon.*

Paint

Sponge or soak in turpentine or solvent recommended as a thinner on label. Launder.

Perfume

Rinse in cold water. Rub undiluted liquid detergent or a detergent paste into stain. Rinse. If stain remains, bleach.

Perspiration

Wash or sponge stain thoroughly with warm water and detergent paste. If perspiration has changed the color of the fabric, restore it by treating with ammonia or vinegar. Apply ammonia to fresh stains; rinse with water. Apply vinegar to old stains; rinse with water.

Rust and Iron

Apply commercial rust remover, Rinse. Or, if safe for fabric, boil stained article in solution of 4 teaspoons of cream of tartar to 1 pint water.

Shoe Polish

Scrape off as much as possible. Pre-treat with a detergent paste; rinse. If stain persists, sponge with rubbing alcohol (1 part to 2 parts water) or turpentine. Remove turpentine by sponging again with warm detergent solution or with alcohol. Bleach if necessary.

Soft Drinks

Sponge with cold water, some stains are invisible when they have dried, but turn brown when heated and may be impossible to remove.

Tar and Asphalt

Act quickly before stain is dry. Sponge with grease solvent or turpentine. Launder.

Urine

Soak in cool water. If stain is dry, work a detergent paste into the spot then rinse. If necessary, bleach.

TROUBLESHOOTING

In most cases, when your washer-dryer fails to work, the problems arising can be easily solved without having to call for a technician. Before calling for assistance, always check these points.

Does not start

- Is the plug correctly inserted into the socket?
- Is there electricity in the house?
- Is the door closed properly?
- Is the start button pressed?
- Is the Washer knob in the correct position for the cycle to start?
- Is the water supply turned on?
- Do any other devices work on that particular Socket?

Does not fill with water

- Is the hose correctly connected to the faucet?
- Is there water supply?
- Is there sufficient water pressure?
- Is the faucet filter clean?
- Is the inlet hose kinked?

Continuously fills and drains water

- Is the drain hose positioned too low?
- Check that the inlet hose is not connected at a height more than 40 inches above the floor.

Does not drain or spin

- Does the selected program incorporate water draining?
- Is the drain pump clogged?
- Is the drain hose kinked?
- Is the coin trap clean?

There are too many suds in the drum

- Is High Efficiency (HE) detergent being used? It is recommended to use HE detergent.
- Is the correct amount of detergent being used?

Vibrates during the spin cycle

- Have all shipping rods been removed during installation?
- Has the machine been leveled correctly?
- Is there space between the machine and adjacent units?
- Is the machine loaded evenly?
- Is the machine installed on carpet or on a wooden floor?

Leaks

- Is the metal ring of the inlet hose properly attached?
- Is the detergent dispenser obstructed?
- Is the drain hose inserted correctly into the drain?

DIAGNOSTIC MENU		
Code	Description	Component
E1	Door close	Door Switch
E2	Drain	Drain Pump
E3	Water inlet	Inlet Valves
E4	Water overflow	Pressure Switch
E5	Motor	Thermal Protector +Electronic Module
E6	Communication between display & electronic module	Communication Cable
E10	Water fill	Water level sensor

To Order parts : www.ApplianceDesk.com/Parts